



Product Catalog 2021

Aluminum railing panels for Commercial and Residential projects, assembled in minutes and shipped directly to you.



NOT FAST.
SUPER FAST.



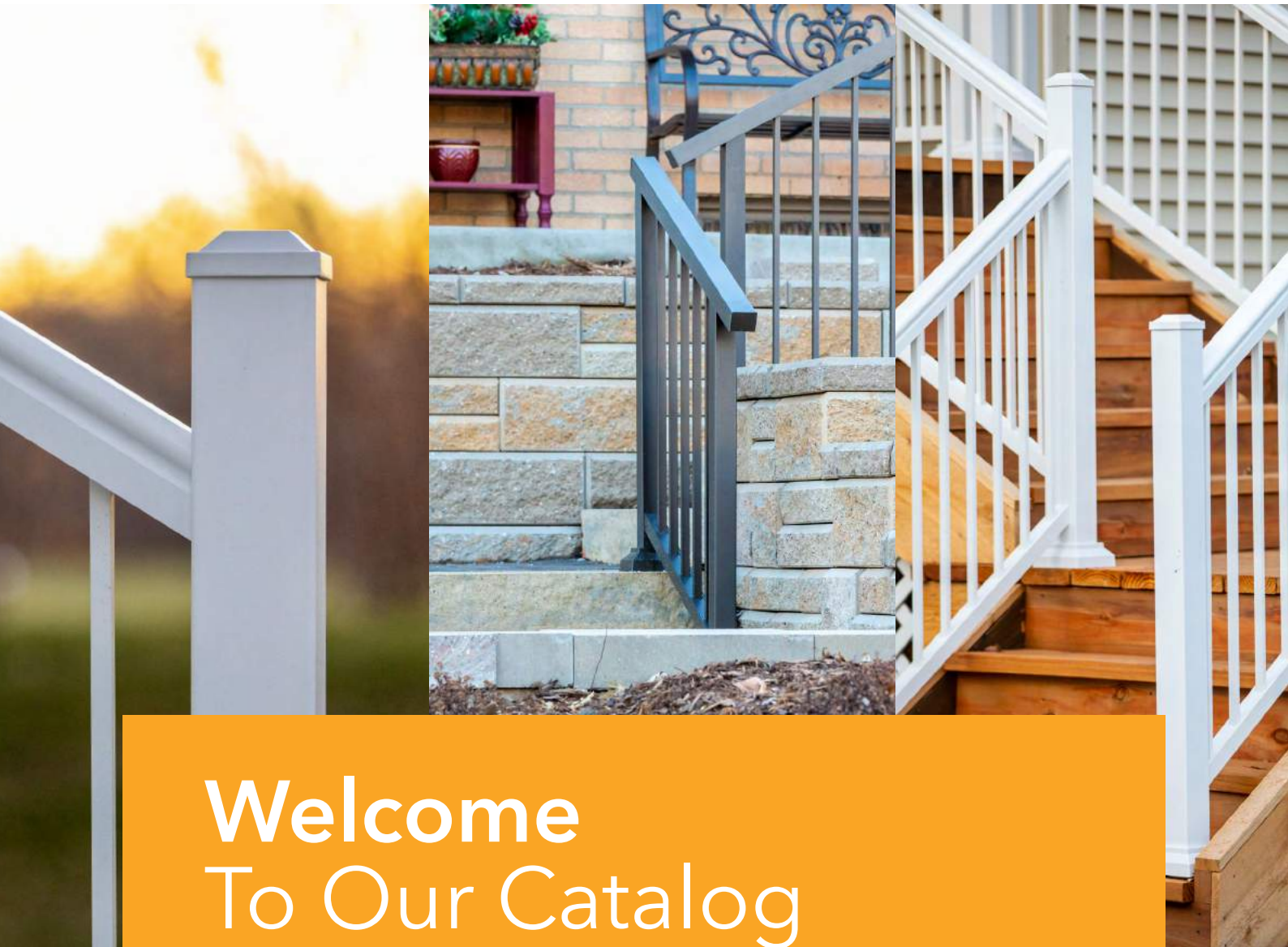

Welcome To Our Catalog

We have effectively streamlined the aluminum railing installation process from design and planning, to order and installation.

We offer aluminum railing panels for either commercial or residential projects assembled in minutes and shipped directly to you. Custom cut, assembled, and ready to install on your job site in days.

Think of Twin Cities Railing as your all-inclusive aluminum railing partner, allowing you to get the highest quality railing faster. Please use this catalog as your product guideline and material estimator. Contact us to place your order:

INFO@TWINCITIESRAILING.COM | 763-270-7063 | TWINCITIESRAILING.COM

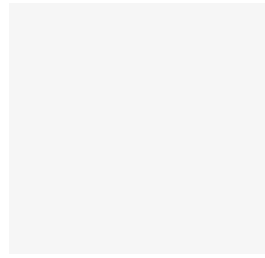
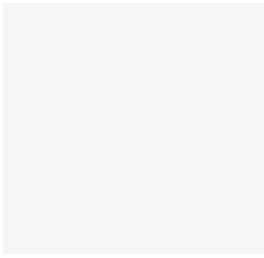
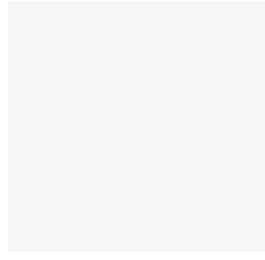
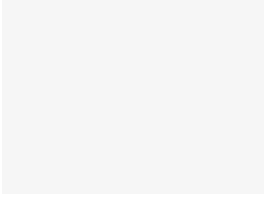

ADA | 22

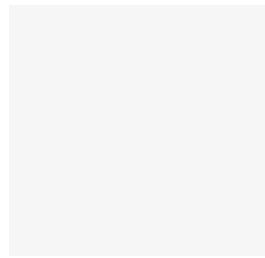

Our Services



763-270-7063

CALL TO SCHEDULE

Call us today to schedule an appointment with a trained installer to come out to your home / job site to measure your project.



RAIL IS CUSTOM FIT

Once measured, we go back to our shop to cut and assemble your custom pieces.



DELIVERED

Twin Cities Railing offers local shipping to Home Owners & Contractors throughout the Minneapolis/St. Paul area. This includes Hennepin, Anoka, Ramsey, Washington, Dakota, Scott, Carver, Wright, & Sherburne Counties. We also offer LTL Delivery Freight Pallets Packs that ship Nationwide, excluding Alaska and Hawaii.

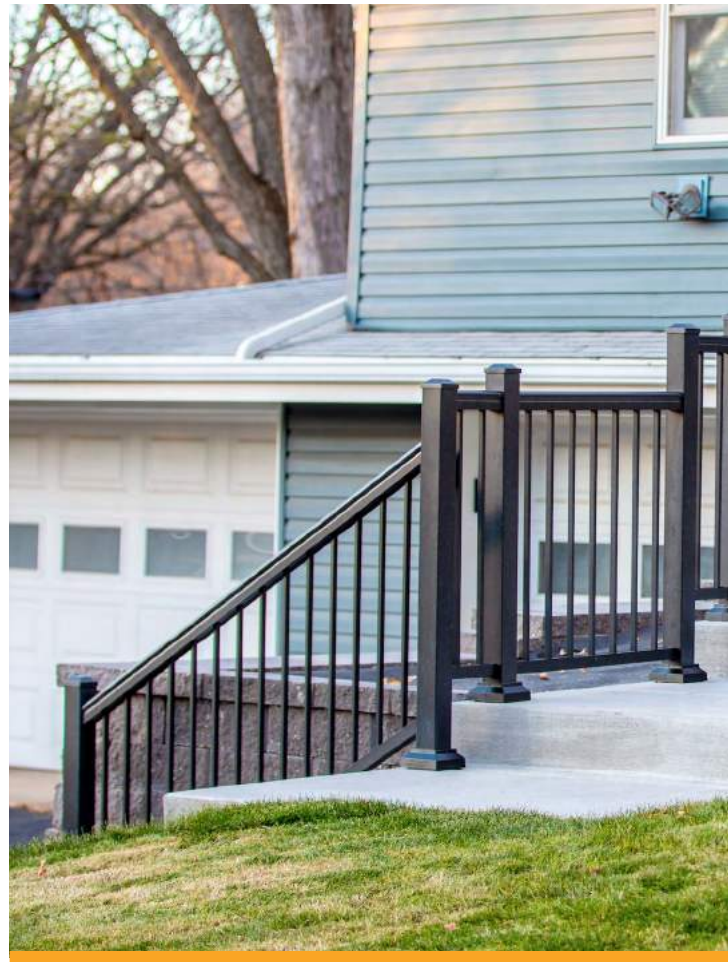

Twin Cities Railing provides Aluminum Railing Solutions for Home Owners, Contractors, Commercial Builders, and Property Managers.

- ✓ **FASTEST LEAD TIME**
- ✓ **FASTEST INSTALLATION**
- ✓ **BEST SERVICE & QUALITY**





THE BIG IDEA BEHIND THE FASTEST RAILING SYSTEM

We are commercial and residential railing experts who have experienced the raising bottlenecks and disruptions in our industry over the years. We're hoping to relieve the frustration of labor shortages, lead time fluctuation, and supply chains.

Through our experiences, passion, and creativity, We created a railing system that works for any installer and has been tested to not only perform better but will maximize profitability.

Using our fast railing system contractors and builders can now effectively improve speed-to-market with a superior product that installs more rapid than any other railing in the industry.

Engineered and Approved to ICC-ES AC273 Commercial and Residential Building Codes.

Textured Powder Coat Colors & Combinations



BLACK



WHITE



BRONZE



BLACK / WHITE



BLACK & BRONZE



BRONZE / WHITE

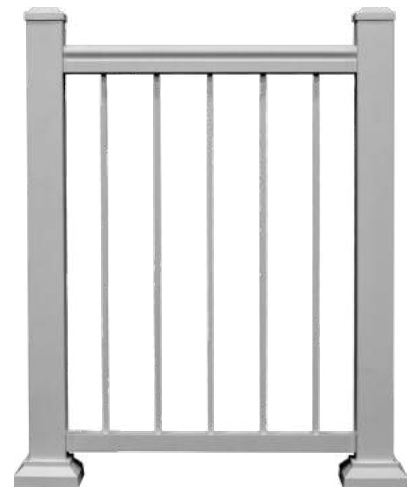

TOP RAIL COLOR OPTIONS



BLACK

WHITE

BRONZE

MAHOGANY

(Victorian Only)



HUNDREDS OF RAILING COMBINATIONS ARE AVAILABLE



Twin Cities Railing panels are preassembled for ease and speed of installation. Our railing systems can be installed in 50% less time than competitive products, and no special tools are required.



ICC CERTIFIED Products

ALUMINUM RAILING SPECIFICATIONS

- 8' Panels - Actual Sizes: 33.5"H X 91.31" or 39"H X 91.31"
- 6' Panels - Actual Sizes: 33.5"H X 69.43" or 39"H X 69.43"
- Baluster Dimensions = 1/2" x 3/4" (.050" wall)
- Baluster Spacing = 3.875"
- Victorian Top Rail - 2.25"H x 2.25"W (.055" wall)
- Alta Top Rail - 1.833"H x 2.25"W (.055" wall)
- Bottom Rail - 1.5" x 1.5" (.055" wall)
- 3" x 3" Posts - Actual Lengths = 38.25", 43.5" and 48" (.065" wall)
- 2" x 2" Posts - Actual Lengths = 34.06", 39.625" and 48" (.090" wall)
- Gate Kits - Actual Sizes: 33.9"H X 48"W or 39.5"H X 48"W

TOOLS RECOMMENDED FOR INSTALLATION



CORDLESS DRILL



LEVEL



TAPE MEASURE



PENCIL



6" #2 SQUARE
DRIVE BIT



MITER SAW
(WITH NONFERROUS BLADE)



BAR CLAMP



84-TOOTH
NONFERROUS BLADE



3/16" DRILL BIT
14" TAPCON DRILL BIT
(concrete applications)
5/16" & 5/8" DRILL BITS
(for LED Lighting application)



SPEED SQUARE

RECOMMENDED HARDWARE

CONCRETE & WOOD APPLICATIONS FOR COMMERCIAL & RESIDENTIAL PROJECTS

(AVAILABLE AT LOWES, HOME DEPOT, AND MENARDS.)



WOOD OR COMPOSITE DECKING

GRK® RSS™ 5/16" x 6"
Exterior Torx/Star Drive



CONCRETE APPLICATIONS

Hilti KH-EZ 1/4" x 3"
Coated with Magni 567



COMPOSITE SHIM FOR POST INSTALLATION

Composite Shim

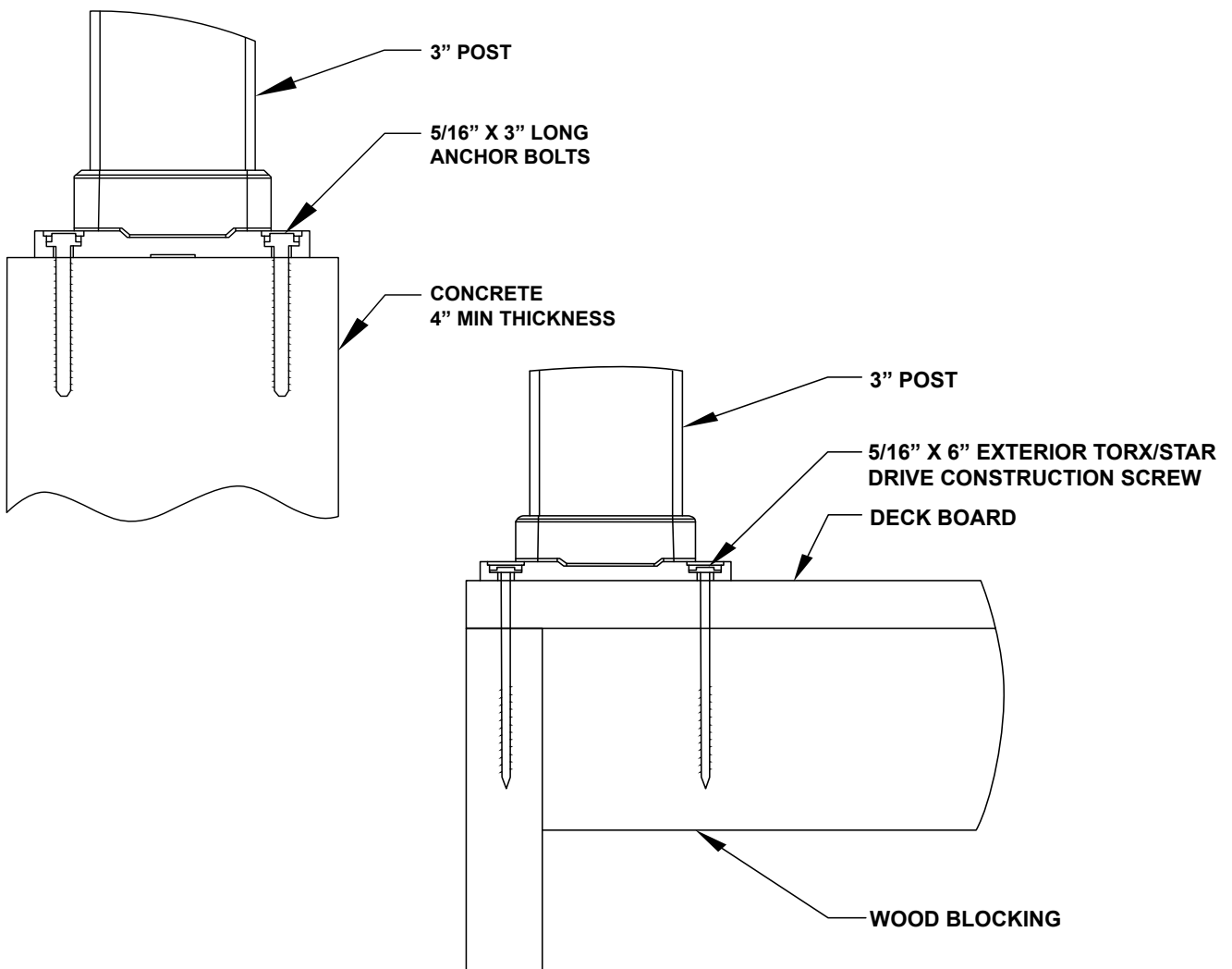

Why We Are Faster

Our railings are ordered to exact size for precise, efficient installation—There is no need to spend time cutting and sizing at the job site.

The hidden fastener system provides a clean, aesthetically pleasing finished product. The system is code-compliant (engineered and approved to ICC-ES AC273 commercial and residential building codes), making it an ideal option for multi-family and commercial clients.

- Pre-Assembled Panels save 20-30 labor minutes per opening
- Average 4-6 hours per deck
- Durable and Aesthetically Pleasing product
- Hidden Fastener System / No Welds or Rivets
- Adaptability in the Field
- ICC-ES AC273 Approved

VICTORIAN

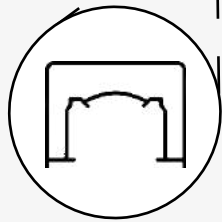

ALTA

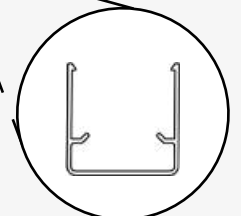

BOTTOM SNAP



RAILING SYSTEMS

Available in mid rail, open mid rail, double mid rail, and glass panel. All available in base mount, wall mount, or fascia mount. **Custom orders contact: info@twincitiesrailing.com**

MOUNTING SYSTEMS

All panels are available in base mount, wall mount, or fascia mount.

POST-TO-POST BASE MOUNT RAILING

3" Intermediate Posts
36" or 42" Standard Height



COMBINATION BASE MOUNT RAILING

3" Posts & 2" Intermediate Posts
36" or 42" Standard Height



CONTINUOUS BASE MOUNT RAILING

2" Posts, Base Mount
36" or 42" Standard Height

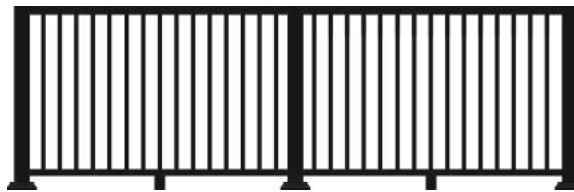

RAILING SYSTEMS - AVAILABLE IN COMBINATION & CONTINUOUS BASE MOUNT RAILING.



POST-TO-POST MID RAIL

3" Post, Base Mount
36" or 42" Standard Height



POST-TO-POST OPEN MID RAIL

3" Post, Base Mount
36" or 42" Standard Height

POST-TO-POST DOUBLE OPEN MID RAIL

3" Post, Base Mount
36" or 42" Standard Height



TOP RAIL COLOR OPTIONS

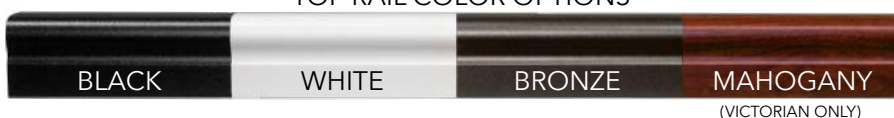

BLACK

WHITE

BRONZE

WHITE & BLACK

BRONZE & BLACK

WHITE & BRONZE

RAILING SYSTEMS



DRINK RAIL

2" Posts, Base Mount (As Shown Above)
36" or 42" Standard Height

AVAILABLE IN:

- 3" Posts & 2" Intermediate Posts
- Continuous & Combination Railing

Available in fascia mount, wall mount, mid rail, open mid rail, double mid rail, glass panel, and glass panel open mid rail.

JULIETTE

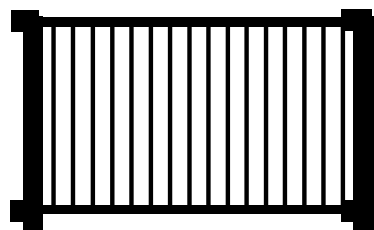

CONTINUOUS

2" Posts
36" or 42" Standard Height

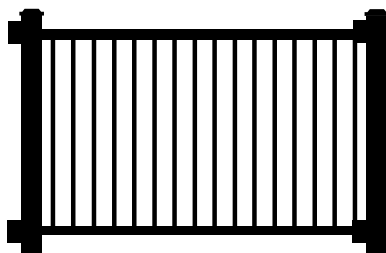

POST-TO-POST

3" Posts
36" or 42" Standard Height



GLASS PANEL RAILING SYSTEMS

Available in base mount, wall mount, fascia mount, combination, or continuous style options.

Custom orders contact: info@twincitiesrailing.com



POST-TO-POST GLASS PANEL OPEN MID RAIL

3" Posts Intermediate Posts
36" or 42" Standard Height



POST-TO-POST GLASS PANEL

3" Intermediate Posts
36" or 42" Standard Height

BLACK

WHITE

BRONZE

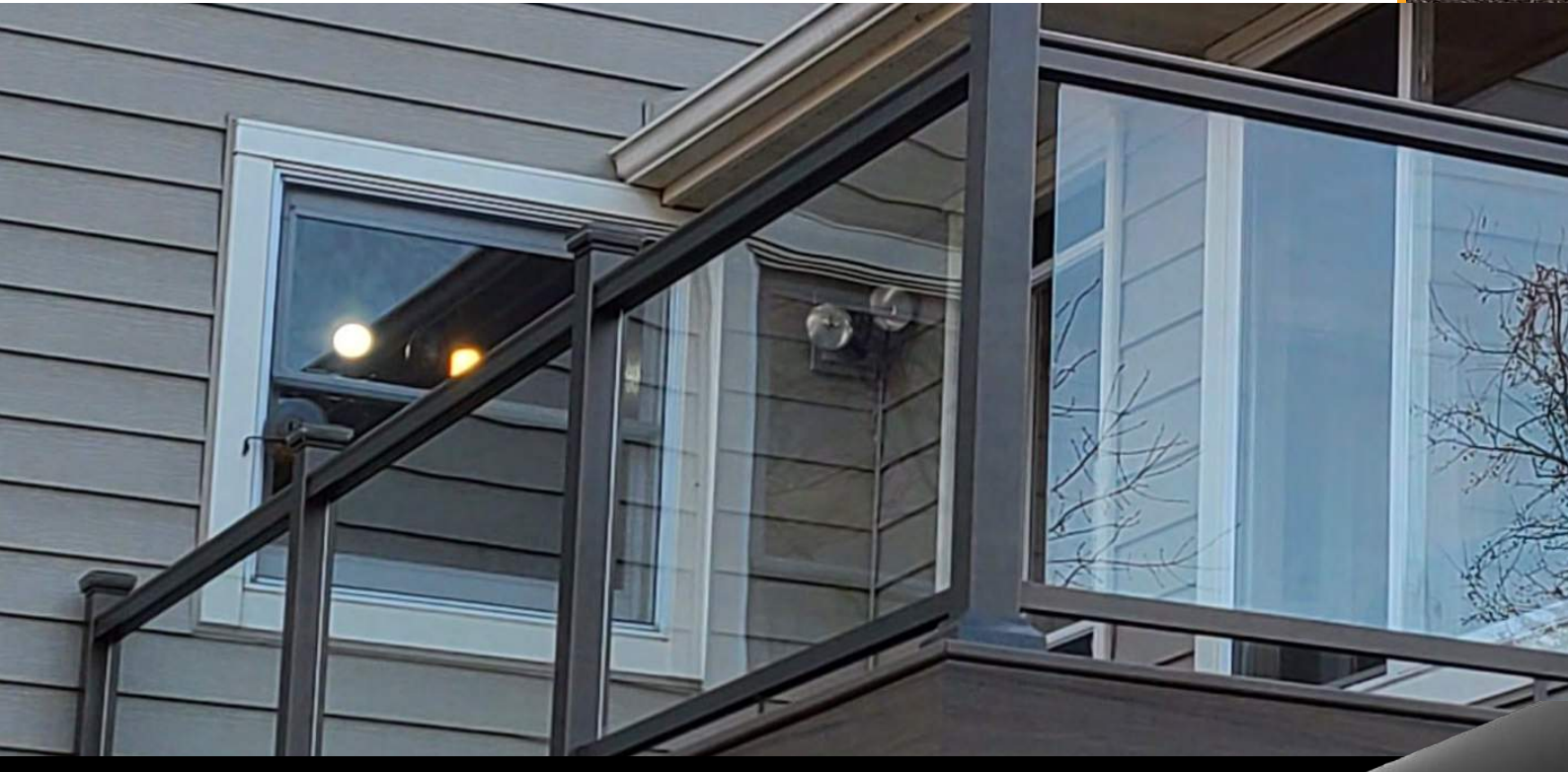

VICTORIAN WALL MOUNT

\$10

B1500 | W1501 | Z1502

ALTA WALL MOUNT

\$10

B1503 | W1504 | Z1505

Colors B W Z



PANELIZED & CUSTOM

WE OFFER TWO TYPES OF SYSTEMS TO BUY FROM



&



Order the panels and posts you need and we will ship directly to you. Then cut your panels on site as you install your railing on your project.

Send us your deck or patio measurements and we will custom cut your entire project before we ship it to you. When your railing arrives it fits and all you have to do is light assembly and installation. Stair components will need to be measured and cut on site.



Twin Cities Railing offers local shipping to Home Owners & Contractors throughout the Minneapolis/St. Paul area. This includes Hennepin, Anoka, Ramsey, Washington, Dakota, Scott, Carver, Wright, & Sherburne Counties. We also offer LTL Delivery Freight Pallet Packs that ship Nationwide, excluding Alaska and Hawaii.

2 STANDARD PICKET OPTIONS

CHOOSE YOUR TOP RAIL

VICTORIAN TOP RAIL



SUPPORT LEG



ALTA TOP SNAP



BOTTOM SNAP

TOP RAIL INCLUDED IN POST-TO-POST



POSTS



+

=

STANDARD PICKET RAILING OPTION



2" Posts are used with continuous railing system.

POST CLIPS ARE PRE-INSTALLED

TOP RAIL PACKAGED SEPERATE IN COMBINATION SYSTEMS

SUPPORT LEG



BOTTOM SNAP

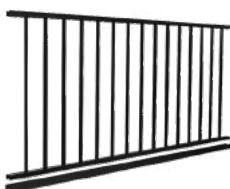

POSTS



CHOOSE YOUR TOP RAIL

VICTORIAN TOP RAIL



ALTA TOP SNAP

+

+

=



2" Posts are used with continuous railing system.

POST CLIPS ARE PRE-INSTALLED

PICKET RAILING SYSTEMS



PICKET PANEL RAILING

Preassembled Aluminum Deck Panels

VICTORIAN	36" X 6'	\$180	1300B 1300W 1300Z
	36" X 8'	\$240	1301B 1301W 1301Z
	42" X 6'	\$195	1309B 1309W 1309Z
	42" X 8'	\$260	1310B 1310W 1310Z
ALTA	36" X 6'	\$180	1303B 1303W 1303Z
	36" X 8'	\$240	1304B 1304W 1304Z
	42" X 6'	\$195	1312B 1312W 1312Z
	42" X 8'	\$260	1313B 1313W 1313Z



CONTINUOUS PICKET PANEL RAILING

Preassembled Aluminum Deck Panels

36" X 6'	\$150	1306B 1306W 1306Z
36" X 8'	\$200	1307B 1307W 1307Z
42" X 6'	\$165	1315B 1315W 1315Z
42" X 8'	\$220	1316B 1316W 1316Z

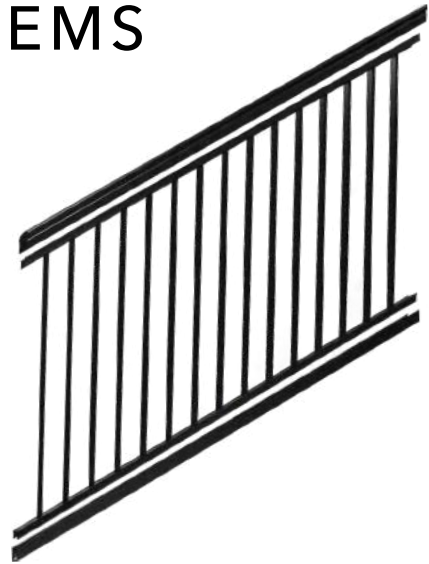

STAIR PICKET PANEL RAILING

Preassembled Aluminum Stair Panels

VICTORIAN

36" X 6'	\$180	1302B 1302W 1302Z
42" X 6'	\$195	1311B 1311W 1311Z

ALTA

36" X 6'	\$180	1305B 1305W 1305Z
42" X 6'	\$195	1314B 1314W 1314Z

MAXIMUM POST SPANS ON STAIR RAILING APPLICATIONS IS 70" ON CENTER.

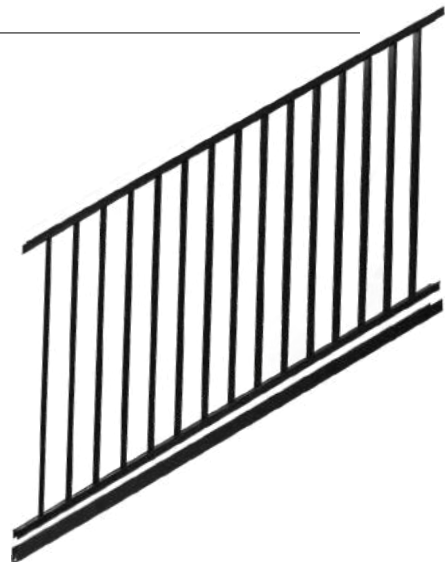

CONTINUOUS STAIR PICKET PANEL RAILING

Preassembled Aluminum Stair Panels

36" x 6'	\$150	1308B 1308W 1308Z
42" x 6'	\$165	1317B 1317W 1317Z

Top rails sold separately with continuous railing system (Pg 32)
 Stair railing panels are shipped at a 37° angle.
 Panels are adjustable and will accommodate 30 - 40° stair angles.
 Over adjusting stair panels will cause loose and rattling pickets.

MAXIMUM POST SPANS ON STAIR RAILING APPLICATIONS IS 70" ON CENTER.

PICKET RAILING SYSTEMS

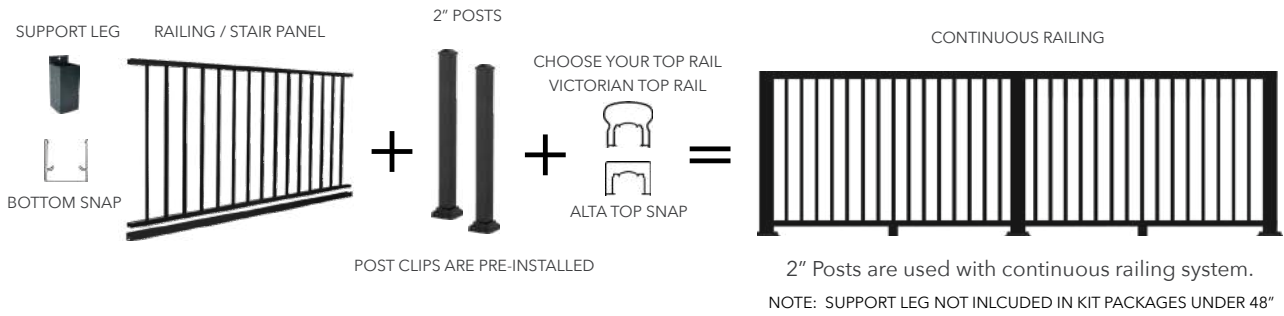

DRINK RAIL PICKET PANEL RAILING

Pre-Assembled Aluminum Drink Rail Panels
 Graspable handrail needed for application on stairs.

NEEDED:

- 1 Drink Rail Bracket - Per Lineal Foot

NOT INCLUDED:

- Top Drink Rail Board
- Fastners to Attach
- Your Beverage of Choice

DRINK RAIL KITS

- Color Matched Clips (6)
- #8 x 3/4" TEK SS Screws (12)
- Bottom Rail Snaps

6' Kit	\$60	1318B	1318W	1318Z
8' Kit	\$80	1319B	1319W	1319Z

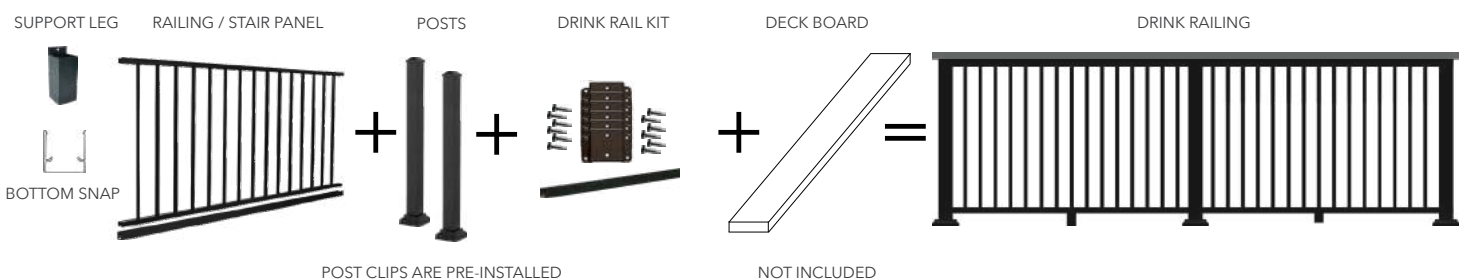

GLASS PANEL & ACCESSORIES

GLASS SYSTEMS ARE ONLY AVAILABLE IN KIT FORM ONLY. NOT CUSTOM.

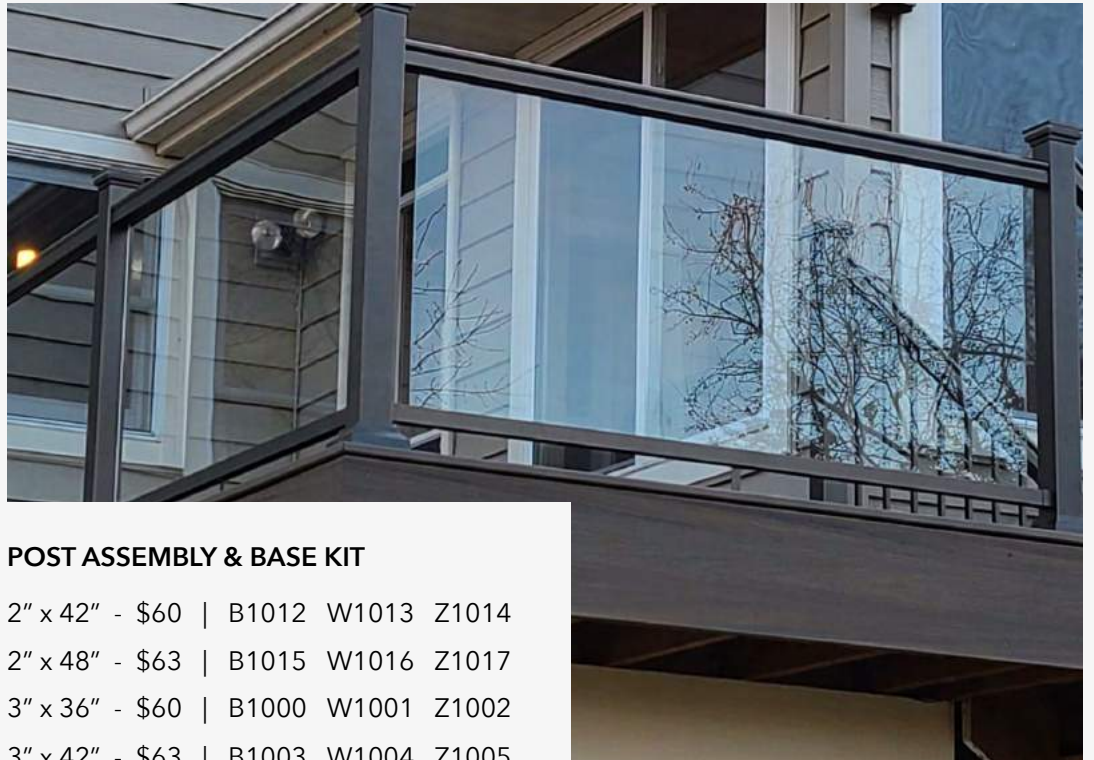

POST ASSEMBLY & BASE KIT

2" x 42" - \$60 | B1012 W1013 Z1014

2" x 48" - \$63 | B1015 W1016 Z1017

3" x 36" - \$60 | B1000 W1001 Z1002

3" x 42" - \$63 | B1003 W1004 Z1005

3" x 48" - \$76 | B1006 W1007 Z1008

Colors B W Z

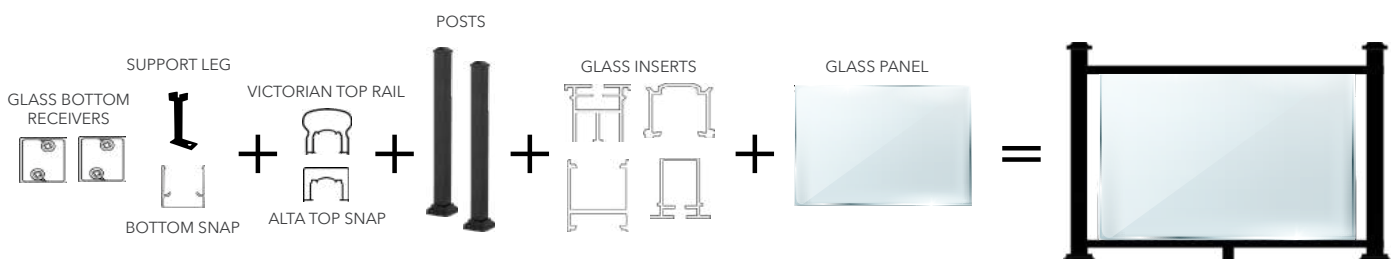



6' TOP GLASS INSERT
\$9 | PN1456



BOTTOM GLASS INSERT
\$10 | PN1457



6' BOTTOM CHANNEL
\$21
B1453 | W1454 | Z1455
Colors B W Z



6' TOP CHANNEL
\$13.50
B1450 | W1451 | Z1452
Colors B W Z

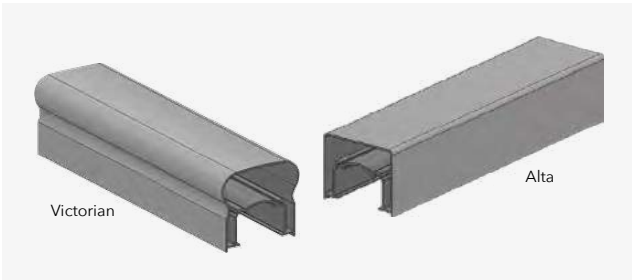

TOP RAIL

VICTORIAN TOP RAIL

- 6' = \$27 B1100 W1101 Z1102
- 8' = \$36 B1103 W1104 Z1105
- 18' = \$75 B1108 W1109 Z1110

ALTA TOP RAIL

- 6' = \$27 B1111 W1112 Z1113
- 8' = \$36 B1114 W1115 Z1116
- 18' = \$75 B1117 W1118 Z1119

Colors B W Z



BOTTOM RECEIVER

\$4
B1458 | W1459 | Z1460
Colors B W Z



GLASS SUPPORT LEG

\$8
B1461 | W1462 | Z1463
Colors B W Z

WHAT YOU WILL NEED COLOR QTY

GLASS PANEL RAILING		
6' Aluminum Frame for Full 1/4" Tempered Glass Panel (Actual length 72", Top Rail not included)		
Top Rail Snap - 6'		
1/4" Tempered Glass Panels (Must be ordered from a local glass company)		
PREASSEMBLED ALUMINUM STAIR PANELS		
36" x 6' Stair Panel (actual length 69.43")		
36" x 6' Continuous Stair Panel (69.43")*		
42" x 6' Continuous Stair Panel (69.43")*		

WHAT YOU WILL NEED COLOR QTY

ALUMINUM POST KITS		
INCLUDES: POST AND BASE PLATE, POST CAP, AND POST BASE VINYL SKIRT.		
36" x 3" Post Kit (actual length 38.25")		
42" x 3" Post Kit (actual length 43.5")		
48" x 3" Post Kit (actual length 48")		
42" x 2" Post Kit (actual length 39.625")		
48" x 2" Post Kit (actual length 48")		
ADDITIONAL KITS		
Continuous Top Rail - 18' Victorian Alta		
Wood Grain Continuous Top Rail - 18' (Victorian Only)		
Wood Grain Top Rail - 8' (Victorian Only)		
Deck & Stair Panel Attach Kit		
22.5° Panel Attach Kit		
45° Wall Mount Kit		
Straight Wall Mount Kit		
Touch-Up Paint		
36" Gate Kit (adjustable up to 50" wide)		
42" Gate Kit (adjustable up to 50" wide)		

GATE KITS



HARMONY 36" | \$350 B1150 | W1151 | Z1152

COMMERCIAL 42" | \$400 B1153 | W1154 | Z1155

AVAILABLE IN KIT ONLY. CONTACT US FOR COLOR CUSTOMIZATION OPTIONS

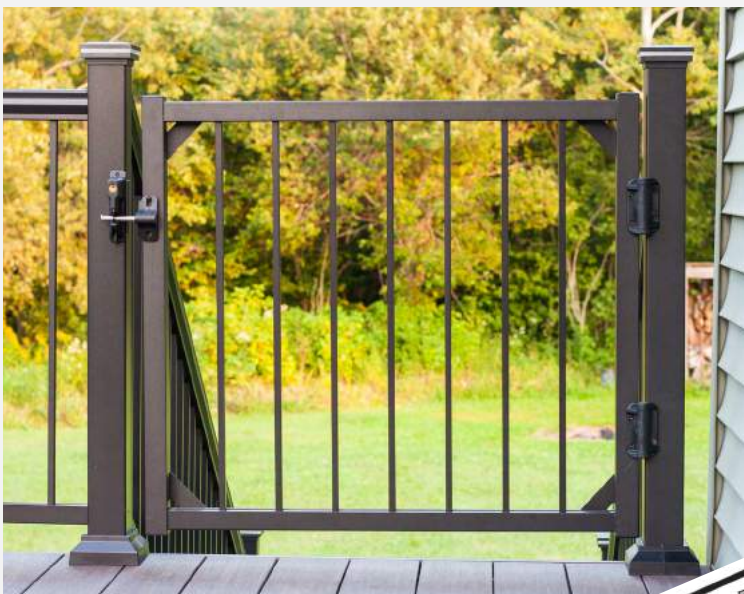
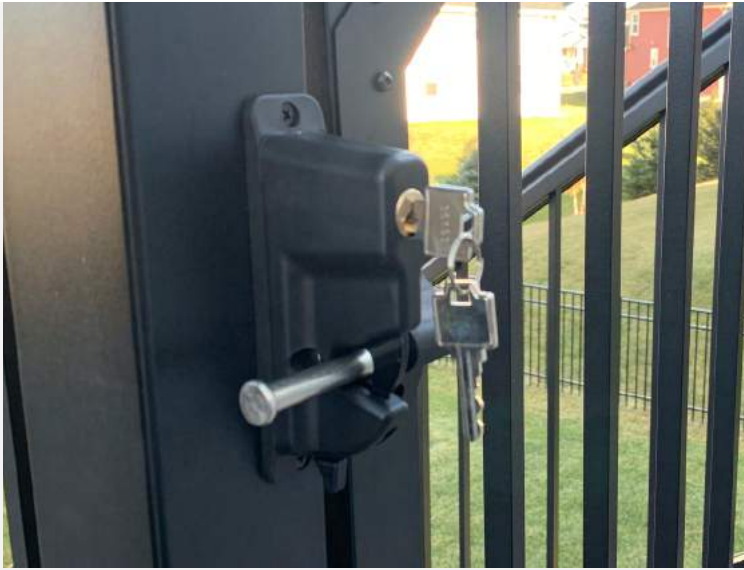

ADA

Kits include printed instructions.
Installation videos are also available on-line.

- ADA (Americans with Disabilities Act) compliant
- Compatible with all aluminum railings including Williams, Aria, and Harmony brand railing
- Beautiful, architectural grade powder coat finish
- Refined fit and finish with aluminum construction
- Convenient kits for simple planning and ordering
- Fast and easy installation _ minimal tools required
- Engineered and tested _ commercial and residential approved
- All necessary hardware included
- Handrail returns, elbows and other individual parts also available special order



\$95



ADA Pipe Rail and 90° Return Kit

- (1) 94" Pipe
- (2) 90° Returns
- (2) 90° Return Covers
- (2) Post Backer Plates
- (2) Joiner Rings
- (6) #10 x 1¹/₂" Tek Screws
- (4) #8 - 1/2" Color Matched Tek Screws
- (1) Installation Instructions

Colors

B1607 | W1608 | Z1609

\$101



ADA Pipe Rail Extension Kit

- (1) 94" Pipe
- (2) 6" Joiners
- (2) Joiner Rings
- (2) Rail Support Brackets with Adapters
- (2) Post Backer Plates
- (2) Support Bracket Caps
- (2) #14 x 1¹/₂" Tek Screws
- (8) #8 x 1/4" Color Matched Tek Screws
- (1) Installation Instructions

Colors

B1601 | W1602 | Z1603

\$120



ADA HANDRAIL LOOP KIT

- (2) Handicap Loops
- (2) Rail Support Brackets with Adapters
- (2) Adjustable Elbows
- (2) Post Backer Plates
- (12) #8 x 1/4" Tek Screws
- (2) #14 x 1 1/2" Tek Screws
- (1) Installation Instructions

Colors

B1610 | W1611 | Z1612



BLACK

WHITE

BRONZE

\$35



ADA 90° Wall Return Kits

- (2) 90° Returns
- (2) 90° Return Covers
- (2) Post Backer Plates
- (2) Joiner Rings
- (6) #10 x 1 1/2" Tek Screws
- (4) #8 - 1/2" Color Matched Tek Screws
- (1) Installation Instructions

Colors

B1604 | W1605 | Z1606

ADA ACCESSORIES & KITS



ADA SUPPORT BRACKET

\$20

Colors   

B1643 | W1644 | Z1645



ADA JOINT RING

\$3

Colors   

B1649 | W1650 | Z1651



90° ELBOW

\$35

Colors   

B1628 | W1629 | Z1630



ADJUSTABLE ELBOW

\$23

Colors   

B1646 | W1647 | Z1648



HAND RAIL

94" \$69 B1613 | W1614 | Z1615

210" \$137 B1616 | W1617 | Z1618

Colors   



ADA RETURN LOOP

\$50

Colors   

B1625 | W1626 | Z1627



38° ELBOW KIT

B1631 | W1632 | Z1633

34° ELBOW KIT

B1634 | W1635 | Z1636

30° ELBOW KIT

B1637 | W1638 | Z1639

5° ELBOW KIT

B1640 | W1641 | Z1642

\$35

Colors   



3" POST BACKER PLATE

\$4 | PN1652



STRAIGHT END WALL MOUNT

\$13

Colors 

B1622 | W1623 | Z1624



ADA END CAP Available in black only.

\$8 | PN1653



RAIL TO BRACKET ATTACHMENT

#8 x 3/4" Tek Screw 20 Pack

Colors 

B1604 | W1605 | Z1606



BRACKET TO METAL POST ATTACHMENT

#10 x 1 1/2" Tek Screw 20 Pack

Colors 

B1604 | W1605 | Z1606



SUPPORT BRACKET ATTACHMENT (PLUG INCLUDED)

#14 x 1 1/2" Tek Screw 20 Pack

Colors 

B1604 | W1605 | Z1606



90° WALL RETURN

\$32

Colors 

B1619 | W1620 | Z1621



INSIDE CORNER MOUNT

\$31

Colors 

B1654 | W1655 | Z1656



INTERNAL PIPE JOINER

\$4 | PN1600



LIGHTING ACCESSORIES



SOLAR 3" LED POST CAP PERIMETER LIGHT

\$47

Colors 

B1027 W1028 Z1029

B = Black | W = White | Z = Bronze

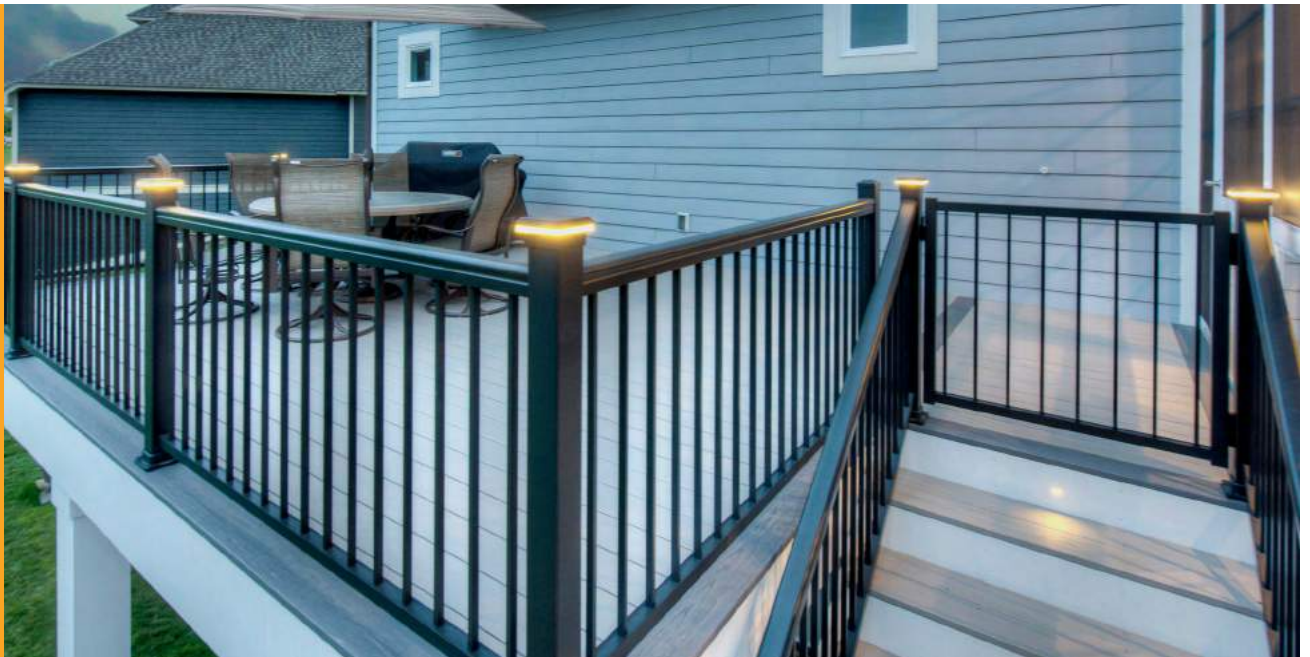
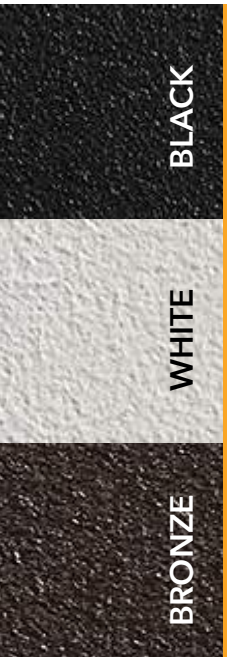
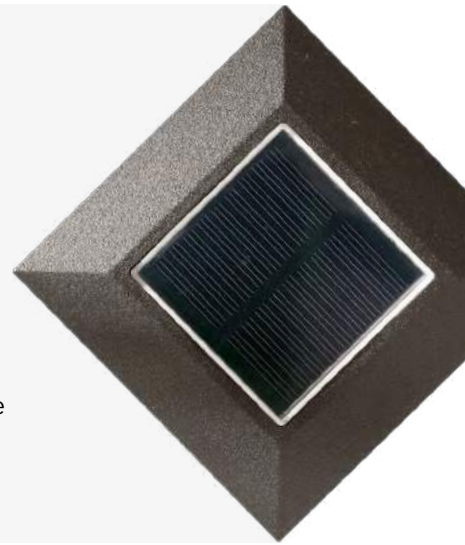

3" LED POST CAP PERIMETER LIGHT

\$49

Colors 

B1160 W1161 Z1162

B = Black | W = White | Z = Bronze

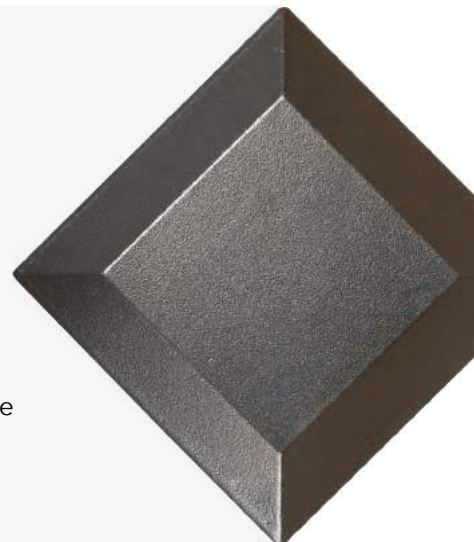

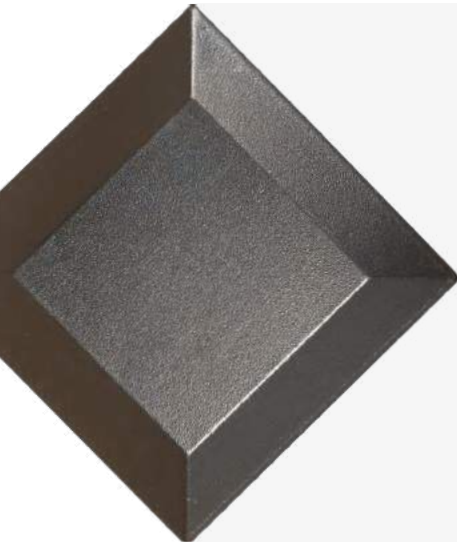

**3" LED POST CAP
INDIRECT LIGHT**

\$49

Colors ● ● ●

B1163 W1164 Z1165

B = Black | W = White | Z = Bronze



BLACK

WHITE

BRONZE

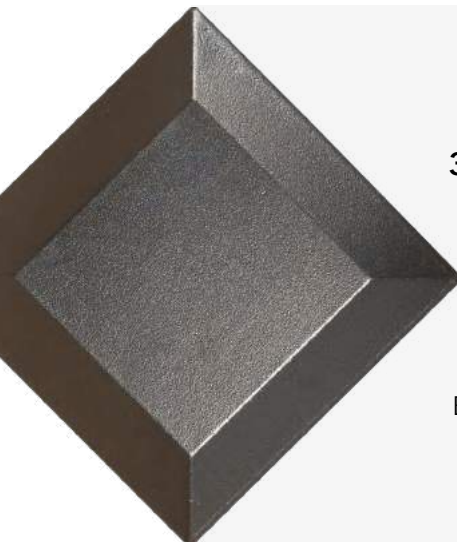

3" LOW PROFILE POST CAP

\$15

Colors ● ● ●

B1024 W1025 Z1026

B = Black | W = White | Z = Bronze



LIGHTING ACCESSORIES & KITS

DEKPRO EFFEX RECESSED STAIR LIGHT

Recessed stair light kits include 10 recessed lights, 36 watt transformer, dimmer w/ remote, photo eye timer, 9' Quick Connect lead wire and 1" forstner drill bit. Designed to be mounted into the riser of a stairway to illuminate the treads. The light is set at a 35 degree angle to cast light directionally onto the steps. Features 2 ea. - 3' Quick Connect leads for easy wiring. For fast installation - lights friction fit into 1" diameter opening. Draws .8 watts per fixture. Light color 3000 - 3500k.

Available in Absolute black, Cocoa Bronze, and Dream White

DOT STAIR LIGHT KIT



ABSOLUTE BLACK DREAM WHITE COCOA BRONZE

UR WIRE CONNECTOR
10 PC KIT

\$15.00
PN 3019

x10

DOT STAIR LIGHT KIT

\$357.00

B3000 | W3001 | Z3002



DOT STAIR LIGHT

2 Count

\$36

B3003 | W3004 | Z3005





DOT STAIR LIGHTS

10 Count

\$180.00

B3021 | W3022 | Z3023

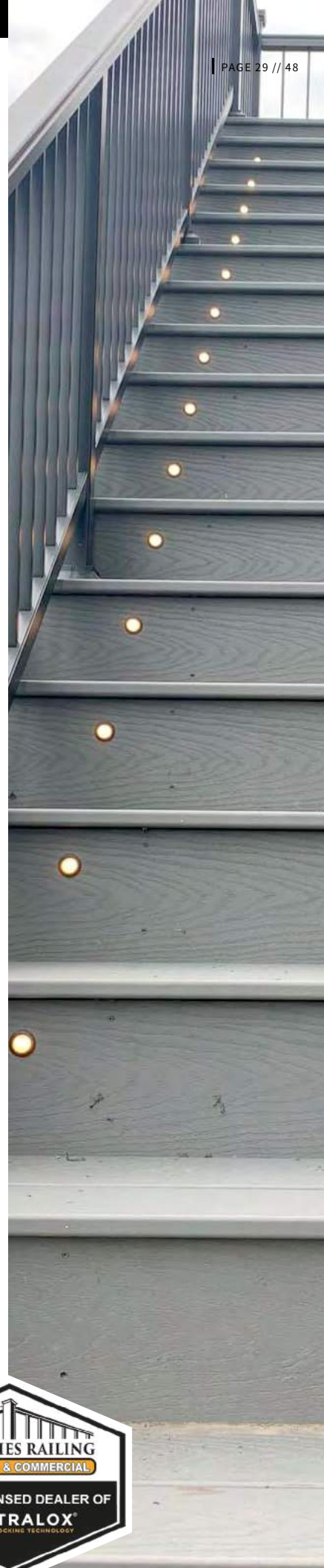
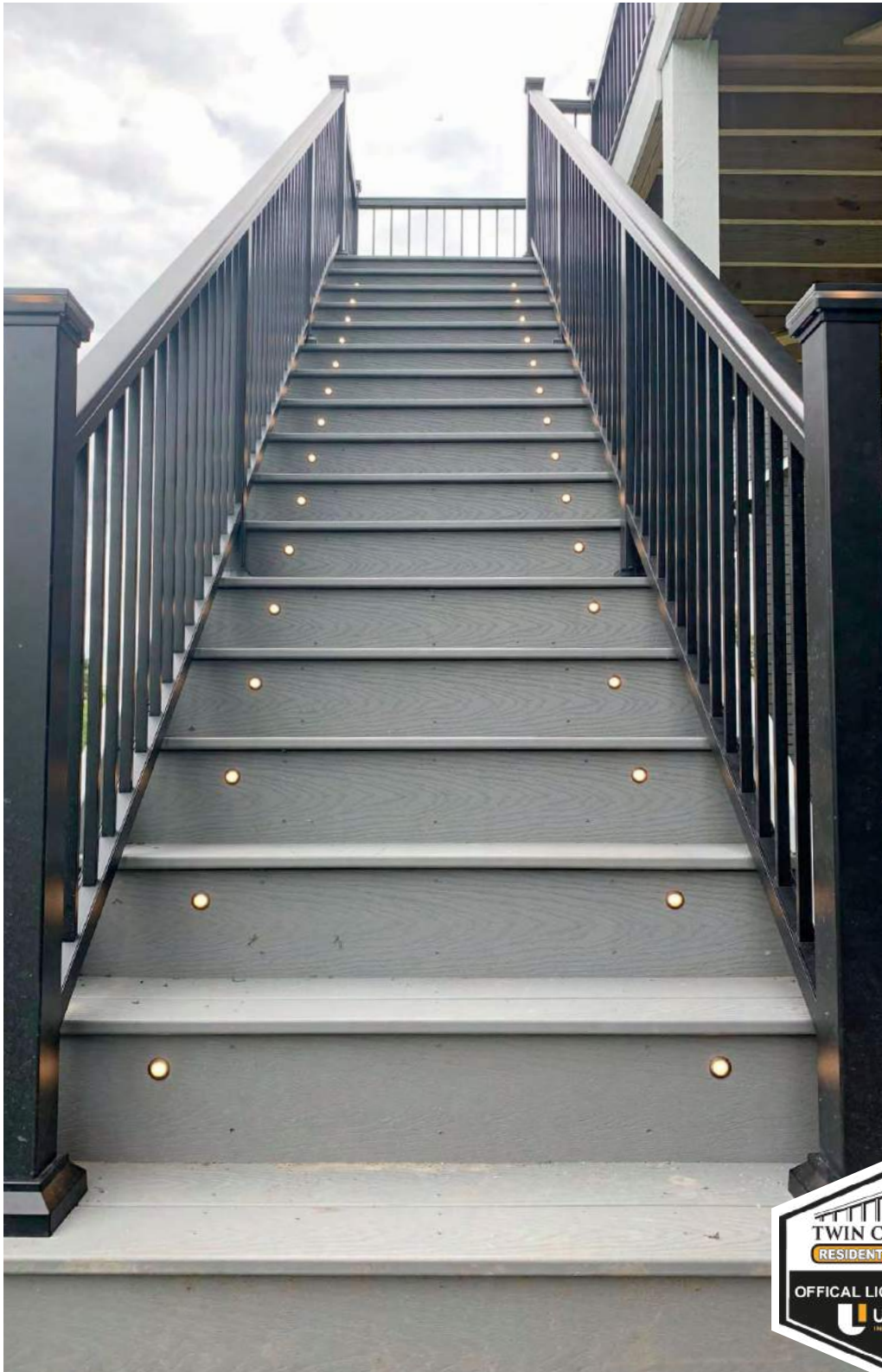

LIGHTING ACCESSORIES & KITS



DekPro™ EFFEX TIMER WITH PHOTO EYE

110 volt photoelectric timer with built in photo eye. Set to on/off at dusk and dawn automatically or on at dusk with 2 - 10 hour run times. Designed for use with any transformer and has two outputs. Plug into outlet and plug transformer into this unit.

\$40 PN3011



DekPro™ EFFEX TRANSFORMER KIT

Kit includes 1 Outdoor DC output transformer w/ Quick Connect lead, 1 timer / photo cell, 1 dimmer with remote and 1 - 9' Quick Connect wire. Dimmer draws 2.5 watts. Determine correct transformer size by adding up wattage of all fixtures. Total wattage should not exceed 80% of the capacity of the transformer.

36 watt - \$195 PN3006

60 watt - \$250 PN3007



DekPro™ EFFEX TRANSFORMER

Outdoor DC output transformer provides power to LED lights. Comes with a Quick Connect output wire. Determine correct transformer size by adding up wattage of all fixtures. Total wattage should not exceed 80% of the transformer. Measures 6-1/2"L x 2"W x 1-1/2"H.

36 watt - \$156 PN3008

60 watt - \$233 PN3009



DekPro™ EFFEX DIMMER

12 volt waterproof remote dimmer, controls on/off and dimming functions for EFFEX series lights and transformers. Requires separate transformer. Works with most DC transformers up to 60 watts. Draws 2.5 watts. Remote range - Approx: 70 ft.

\$60 PN3010



HEAVY DUTY OUTDOOR LOW VOLTAGE WIRE

Heavy duty low voltage wire rated for direct burial

WIRE - 12 GA 100' SPOOL \$76.00 PN3013 (Required for longer runs over 200')

WIRE - 18 GA 100' SPOOL \$40.00 PN3015

WIRE - 12 GA 250' SPOOL \$193.00 PN3014

WIRE - 18 GA 250' SPOOL \$95.00 PN3016

(recommended for most LED lighting applications)

LIGHTING ACCESSORIES & KITS

Power Supply Diagram

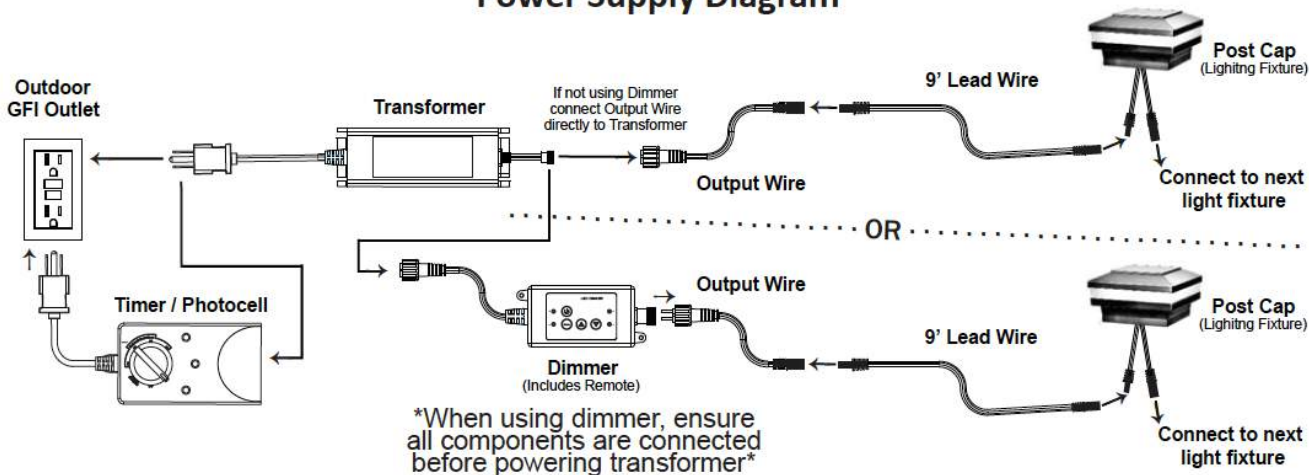

DekPro™ EFFEX 9' QUICK CONNECT CABLE

Connect into DekPro™ EFFEX lighting components. Used when running wiring through top rail of aluminum railing system (i.e. DekPro™ Prestige).

\$8 PN3012



DekPro™ EFFEX IN-LINE CONNECTOR CABLE

Used optionally, this 6' cable enables post caps to be wired by tapping into 12 Gauge perimeter wire below the deck and transferring the power up the post and to the lighting fixture. Provides a watertight connection.

\$7 PN3021

DekPro Quick Connect System



1" FORSTNER BIT

Forstner bit for DekPro™ EFFEX and EZ Series Installations.

1" Forstner Bit (DekPro™ EFFEX) \$14.00 PN3017

TOP RAILING & BOTTOM SNAPS



VICTORIAN TOP RAIL

ACTUAL
 69.43" 6' = \$27
 91.31" 8' = \$36
 216" 18' = \$75

6' = B1100 | W1101 | Z1102
 8' = B1103 | W1104 | Z1105
 18' = B1108 | W1109 | Z1110

Colors **B** **W** **Z**



ALTA TOP RAIL

6' = \$27
 8' = \$36
 18' = \$75

6' = B1111 | W1112 | Z1113
 8' = B1114 | W1115 | Z1116
 18' = B1117 | W1118 | Z1119

Colors **B** **W** **Z**



BOTTOM RAIL SNAP

6' = \$14
 8' = \$18
 18' = \$54

6' = B1120 | W1121 | Z1122
 8' = B1123 | W1124 | Z1125
 18' = B1126 | W1127 | Z1128

Colors **B** **W** **Z**

FASCIA MOUNT BRACKETS

INCLUDES SCREWS FOR ATTACHING BRACKETS TO POSTS. BRACKET MOUNTING FASTENERS SUPPLIED BY OTHERS.



POST FASCIA

2" = \$34
 3" = \$36

2" - B1434 | W1435 | Z1436
 3" - B1425 | W1426 | Z1427

Colors **B** **W** **Z**



POST OUTSIDE 90°

2" = \$37
 3" = \$39

2" - B1440 | W1441 | Z1442
 3" - B1431 | W1432 | Z1433

Colors **B** **W** **Z**



POST INSIDE 90°

2" = \$37
 3" = \$39

2" - B1437 | W1438 | Z1439
 3" - B1428 | W1429 | Z1430

Colors **B** **W** **Z**

ACCESSORIES



SUPPORT LEG
\$4

B1265 | W1266 | Z1267
Colors B W Z



#8 x 3/4" TEK SCREWS
S.S. - 25¢ | SS1254

39¢
B1255 | W1256 | Z1257
Colors B W Z



WALL MOUNT
\$10

ALTA
B1503 | W1504 | Z1505
VICTORIAN
B1500 | W1501 | Z1502
Colors B W Z



2" CROSSOVER BRACKET
\$7
PN1250



2" STAIR CROSSOVER BRACKET
\$7
PN1251



#14 x 2 WALL MOUNT WOOD SCREW
EXTERIOR GRADE 30¢
PN1509



STRAIGHT CLIPS
85¢
PN1252



STAIR CLIPS
90¢
PN1253



DRINK RAIL BRACKET HAT
\$9
B1400 | W1401 | Z1402
Colors B W Z

MISC.



CONTINUOUS CORNER KITS

- ALTA 90°** \$45
B1212 | W1213 | Z1214
- ALTA 45°** \$36
B1209 | W1210 | Z1211
- VICTORIAN 90°** \$45
B1221 | W1222 | Z1223
- VICTORIAN 45°** \$36
B1218 | W1219 | Z1220



TOP RAIL STAIR CUT COLLAR

- \$1.25
- ALTA**
B1227 | W1228 | Z1229
- VICTORIAN**
B1203 | W1204 | Z1205
- Colors



1.5" COLLAR

- \$1.25
- ALTA**
B1224 | W1225 | Z1226
- VICTORIAN**
B1200 | W1201 | Z1202
- Colors



3" POST CAP

- \$5
- Colors
- B1021 | W1022 | Z1023



BASE SKIRT VINYL

- \$6
- Colors
- PN1030



END CAPS

- \$10.00
- ALTA** B1206 | W1207 | Z1208
- VICTORIAN** B1215 | W1216 | Z1217
- Colors

#8 X 3/4" TEK KITTED

\$5 (20 pack)

Colors ● ● ●
PN1254



#8 X 1 1/2 TEK SCREW SS

Stainless Steel PN1261
33¢ per | \$2.50 (8 pack)

Colors ● ● ●
40¢ per | \$3 (8 pack)
B1261 | W1261 | Z1261

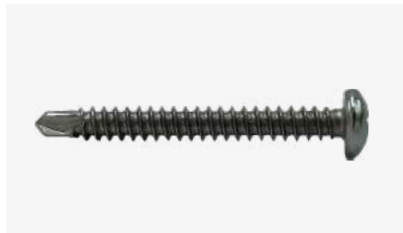

1 1/2" TEK SCREWS SS

\$2.50 (8 Pack)

PN1261



TOUCH UP

PAINT \$10.00
B1175 | W1176 | Z1177

SPRAY \$39.00
B1178 | W1179 | Z1180

Colors ● ● ●

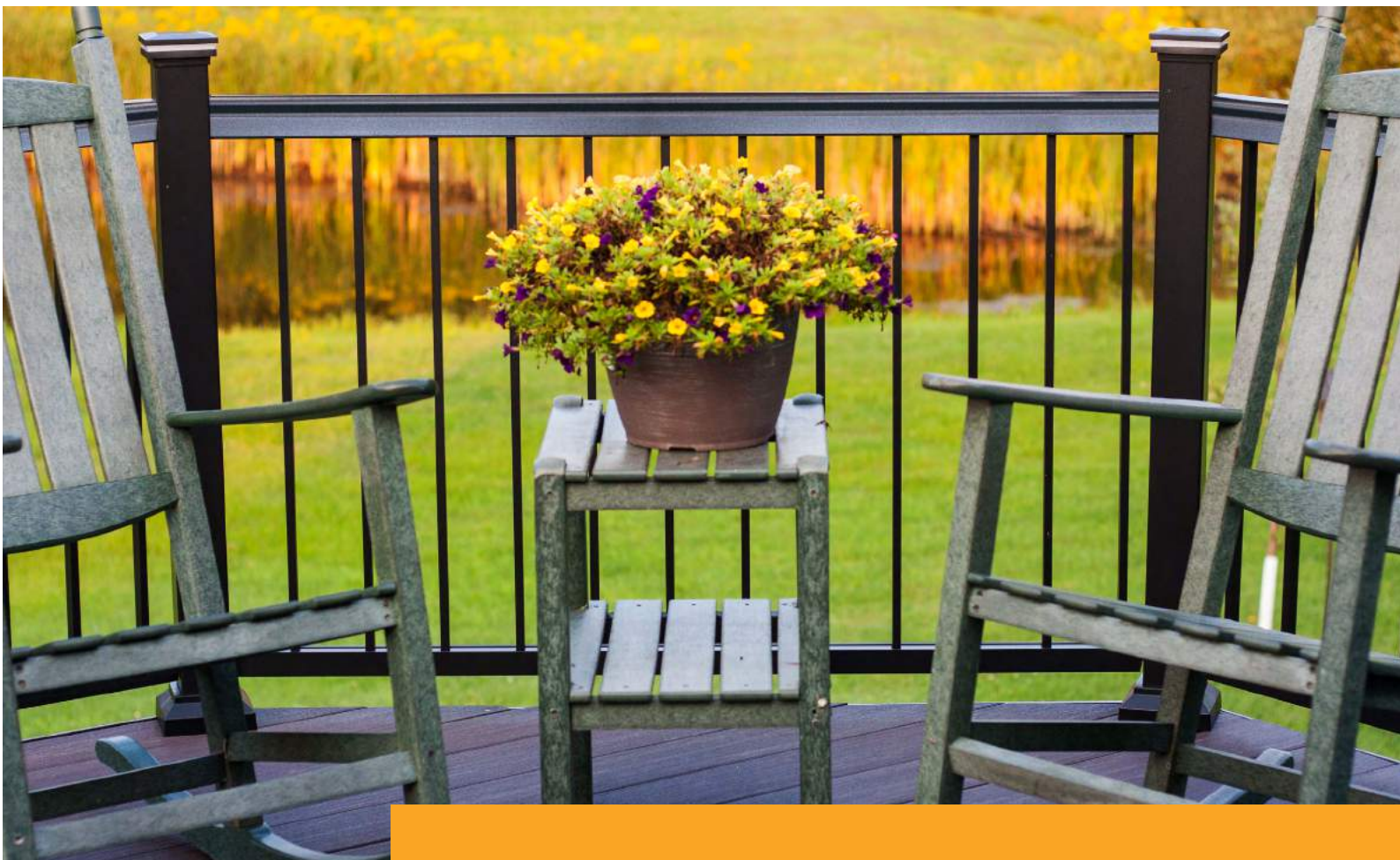

Why VERSATEX?

Because VERSATEX is created from cellular PVC, it is moisture and insect resistant while still featuring the real cedar look and woodworking characteristics a fine builder or craftsman desires. The result is a product limited only by your imagination. VERSATEX is an ideal solution for moisture sensitive areas, including those along coastal zones or regions affected by salt and high humidity. Most of the problems associated with wood trims are eliminated with VERSATEX. No more warping, cupping, or splitting – just a Trimboard with high aesthetic value backed by a lifetime warranty.



GET THE LOOK YOU WANT

We offer two finishes: Smooth Matte and Timber Ridge. VERSATEX Trimboards can be ordered either Smooth/Smooth or Smooth/Timber Ridge.

MORE LIKE REAL WOOD

Timber Ridge is designed with a more natural surface texture to compliment cedar and fiber cement.

VERSATEX EDGES ARE "RIGHT"

VERSATEX Trim is cut with a proprietary system to keep the edges sealed, clean, and dimensionally accurate with true 90° angles.

THICKER OPTIONS

Our 1½" Trim makes it easier to create thick pergola rafters, custom mouldings, and window casings.

TIMBER RIDGE FINISH



SMOOTH FINISH



VERSATEX is the first manufacturer to produce 1½" material, available in 48" wide Sheet.

- Can be used in direct contact with masonry
- Can be used in direct contact with moisture
- Does not require painting
- Weather resistant
- Resists insects
- Resists rot



ANYTHING WOOD CAN DO...



VERSATEX CAN DO BETTER...



WIDTH	NOMINAL	2"	3"	4"	5"	6"	8"	10"	12"	16"
	ACTUAL	1½"	2½"	3½"	4½"	5½"	7¼"	9¼"	11¼"	15¼"

THICKNESS	ACTUAL	2"	3"	4"	5"	6"	8"	10"	12"	16"
	5/8" = 5/8"				■		■	■	■	■
1" = 3/4"		■	■	■	■	■	■	■	■	■
5/4" = 1"				■	■	■	■	■	■	■
6/4" = 1¼"				■		■	■	■	■	
8/4" = 1½"				■		■	■	■	■	

- 5/8", 1" and 5/4" available in standard 12', 18' & 20' lengths; 6/4" & 8/4" available in standard 18' lengths
- Custom lengths and widths available in "Smartpack" quantities
- Most thicknesses can be ordered reversible - Smooth/Timber Ridge or Smooth/Smooth
- 1½" thick Trimboards may be subject to extended lead times
- Sizes also available in **PEELNEAT** with a protective film applied

VERSATEX

BEAUTY OF WOOD. DURABILITY OF PVC.



The VERSATEX Stealth Trim System is designed with the builder in mind.

VERSATEX[®] BUILDING PRODUCTS



TRIMBOARD NAILING FLANGE

\$75 1" x 3.5" x 18' PN2010
\$101 1" x 5.5" x 18' PN2011



TRIMBOARD STEALTH NAILING FLANGE

\$75 1" x 3.5" x 18' PN2014
\$101 1" x 5.5" x 18' PN2015



STEALTH BEADBOARD

\$74 1/2" x 6" x 18' PN2023



STEALTH SKIRTBOARD

\$100 3/4" x 8" x 18' PN2024

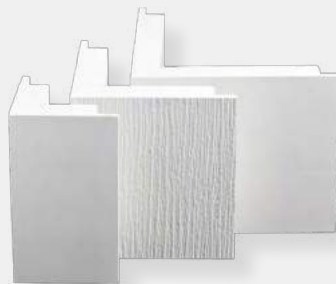

**TRIMBOARD STEALTH
CORNER**

\$76 1" x 3.5" x 10' PN2018
\$76 1" x 5.5" x 10' PN2019

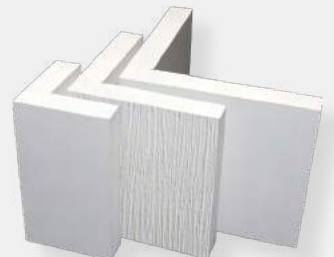

TRIM CORNER

\$82 1" x 3.5" x 10' PN2016
\$111 1" x 5.5" x 10' PN2017

VERSATEX

BEAUTY OF WOOD. DURABILITY OF PVC.



TIMBER RIDGE

SMOOTH

TRIMBOARD FILMED

Most thicknesses can be ordered reversible:
Smooth/Timber Ridge or Smooth/Smooth

\$45	3/4" x 3.5" x 18'	PN2000
\$70	3/4" x 5.5" x 18'	PN2001
\$79	3/4" x 7.25" x 18'	PN2002
\$101	3/4" x 9.25" x 18'	PN2003
\$123	3/4" x 11.25" x 18'	PN2004
\$58	1" x 3.5" x 18'	PN2005
\$78	1" x 5.5" x 18'	PN2006
\$103	1 x 7.25" x 18'	PN2007
\$131	1" x 9.25" x 18'	PN2008
\$159	1" x 11.25" x 18'	PN2009

Our system allows for faster and more aesthetically pleasing installations time after time. The 3/4" pockets accommodate any siding product including fiber cement, cedar and vinyl, and our Stealth Skirtboard is the answer to meeting manufacturers' ground, asphalt, concrete or deck clearance for fiber cement sidings as well as composite and wood sidings.

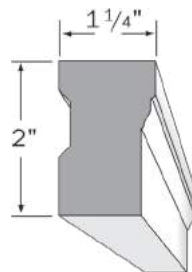

SMOOTH MOULDING

\$35

1 1/4" x 2" x 17'6"

PN2025

\$11

5/8" x 3/4" x 16'

PN2026

VERSATEX
BUILDING PRODUCTS



WE SURROUND YOU
WITH OPTIONS.

VERSATEX[®]

BUILDING PRODUCTS

EXPERIENCE THE VERSAWRAP - At VERSATEX, we pride ourselves on coming up with innovative ways to make the builders' lives easier during installation. When we were asked to make covering wood posts more efficient with still improving aesthetics, we delivered the VERSAWRAP.

The unique design of VERSAWRAP features a product cut with pre-mitered grooves and friction fit joints. The joints are inter-locking with a unique design to allow for easy alignment and additional surface area for bonding.



CROWN KIT

\$15	4"	PN2062
\$19	6"	PN2063
\$24	8"	PN2064

VERSA WRAP

\$144	4" x 4" x 10'	PN2048
\$212	6" x 6" x 10'	PN2052
\$324	8" x 8" x 10'	PN2057

BASE MOULDING KIT

\$12	4"	PN2050
\$14	6"	PN2054
\$18	8"	PN2059

ACCENT WRAP

\$31	4" x 4" x 10'	PN2049
\$42	6" x 6" x 10'	PN2053

BED XL KIT

\$16	4"	PN2051
\$19	6"	PN2056
\$23	8"	PN2060

VERSAWRAP TRIM KITS

4" Wraps	6" Wraps	8" Wraps
Base Moulding Kit	Base Moulding Kit	Base Moulding Kit
Bed Moulding Kit	Bed Moulding Kit	Bed Moulding Kit
Bed Moulding Kit XL	Bed Moulding Kit XL	Bed Moulding Kit XL
4" Crown Moulding Kit	4" Crown Moulding Kit	4" Crown Moulding Kit
4" Crown Moulding Kit XL	4" Crown Moulding Kit XL	4" Crown Moulding Kit XL

- All kits are pre-cut to length, mitered, and sold in bags with Hoffman Dovetail Connectors for easy assembly and a snug fit around the outside dimension of specific sized column wraps.
- XL kits are cut longer to fit around outside dimension of Accent Wraps.
- All Crown Moulding Kits are made with 4" Crown Mould profile (3 5/8" actual).



Our four-piece Tapered column wrap provides the same convenience of the one-piece VERSAWRAP for a craftsman style project. Four pre-cut panels each have a friction-fit miter lock joint to eliminate the calculations and cuts required to ensure the right angle for each panel.

TAPERED COLUMN WRAP KIT

\$500 16" x 16" x 6' PN2047

Column tapers from 16" wide at the base to 12" wide at the top. Price includes trim kit for top and bottom.

*Moulding kits are pre-cut to length and mitered.



TAPERED COLUMN WRAP KIT

\$400 12" x 12" x 6' PN2046

Column tapers from 12" wide at the base to 8" wide at the top. Price includes trim kit for top and bottom.

VERSAWRAP



RAISED PANEL #2
 \$392 6" x 6" x 8'6" PN2055
 \$545 8" x 8" x 8'6" PN2058

4" POST CAPS
 \$35
 PN2061

VERSATEX
 BUILDING PRODUCTS

VERSATEX - CANVAS SERIES

WEATHERED GREY

AMBER

MACORE

WALNUT



The VERSATEX Canvas Series has been developed to add contrast to your porch ceilings and interior trim projects. This innovation combines an exterior grade laminate featuring warm woodgrain finishes with long-lasting, maintenance-free VERSATEX profiles. Through the Canvas Series, VERSATEX delivers the look of rich hardwoods without knots and without labor-intensive re-staining requirements.



4" CROWN MOULDING

\$72.00 9/16" x 3 5/8" x 16'

WEATHERED GREY	PN2041
AMBER	PN2038
MACORE	PN2039
WALNUT	PN2040

WP4 TONGUE & GROOVE

\$132 3/4" x 5 1/2" x 18'

WEATHERED GREY	PN2037
AMBER	PN2034
MACORE	PN2035
WALNUT	PN2036



Cost Comparison & Longevity

Chart based on a 240 ft² porch ceiling finished with a WP4 profile, excluding mouldings. Pricing is calculated based on specific geographic market data for both materials and labor and should not be considered definitive for specific projects. Coastal areas can accelerate need for restaining.

	<i>Canvas Series</i>	Cedar	Cypress	Mahogany
Initial Cost (stained & installed)	\$4,045	\$2,874	\$3,526	\$3,778
Restaining & Maintenance	\$0	\$600 every 4 years	\$600 every 4 years	\$600 every 3 years
4 Year Cost	\$4,045	\$3,474	\$4,126	\$4,378
8 Year Cost	\$4,045	\$4,074	\$4,726	\$4,978
12 Year Cost	\$4,045	\$4,674	\$5,326	\$6,178



“Ceilings are often left plain, but they can really go a long way in establishing style and personality. With the Canvas Series, this big impact doesn’t come along with on-going maintenance.”



VERSATEX
BUILDING PRODUCTS

STARBORN PRO PLUG TOOL

\$24 | PN2033



CRAYON & MARKER

- \$25 Amber PN2042
- \$25 Macore PN2043
- \$25 Walnut PN2044
- \$25 Grey PN2045



TIMBER RIDGE

- 75 Screws / 80 Plugs \$34 (10) 2 3/4" PN2030
- 375 Screws / 400 Plugs \$118 (10) 2 3/4" PN2031
- 1125 Screws / 1200 Plugs \$330 (10) 2 3/4" PN2032

SMOOTH

- 75 Screws / 80 Plugs \$34 (10) 2 3/4" PN2029



SCREEN PORCH

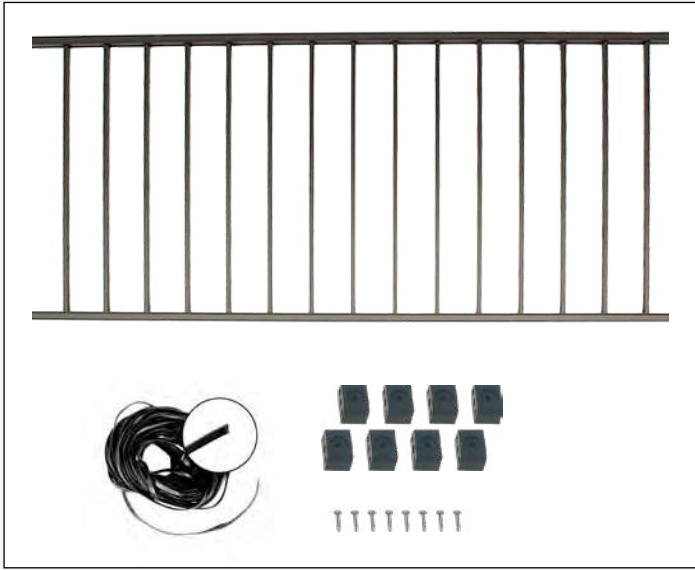

36" x 6' Railing Panel Kit

\$140 B1812 | W1813 | Z1814

Colors B W Z



Door Frame Kit

\$213 8.5" B1836 | W1837 | Z1838
 \$262 12' B1839 | W1840 | Z1841

Colors B W Z



Perimeter Channel Kit

\$73 36" B1806 | W1807 | Z1808
 \$90 42" B1809 | W1810 | Z1811

Colors B W Z



Screen Porch Post Kit

\$85 8.5" B1800 | W1801 | Z1802
 \$116 12' B1803 | W1804 | Z1805

Colors B W Z

SCREEN PORCH



Roll of Spline 100'

\$10

PN1849



Roll of Screen 100'

\$155 6' x 100'

Charcoal ●

PN1850

Standard 32"x80" powder-coated aluminum screen doors. Includes Frame and Door. Available in Black, White, or Bronze.

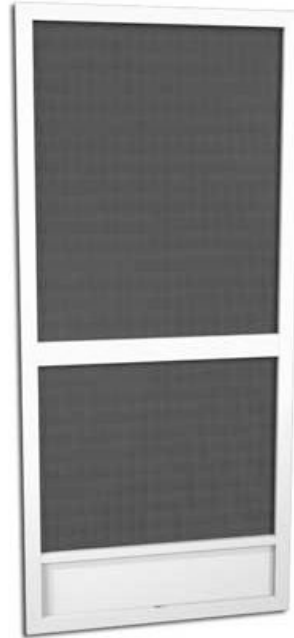

Canoe Creek Screen Porch Door

\$250

- B1843
- W1844
- Z1845

ORDER SIZE	ROUGH OPENING	RANGE OF ADJUSTMENT	
		WIDTH	HEIGHT
36 x 80	36 x 80	35-1/2 to 36-1/2	79-3/4 to 80-3/4
32 x 80	32 x 80	31-1/2 to 32-1/2	

Westmore A-500 Screen Porch Door

\$275

- B1846
- W1847
- Z1848

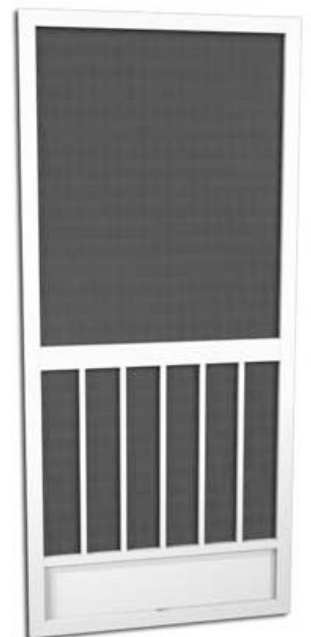

NOTE:
Color finish on screen doors vary from screen rail kit systems.





14144 NORTHDAL BLVD,
ROGERS, MN 55374
INFO@TWINCITIESRAILING.COM
(763) 270-7063